

COMPOSITE POLES AND PRODUCTS FOR POWER TRANSMISSION AND DISTRIBUTION

GET THE SHAKESPEARE COMPOSITE ADVANTAGE

LEADERS CHOOSE LEADERS

- Crafting composite innovations for more than 65 years, Shakespeare designs and produces exceptionally tough, durable products for customers requiring superb performance.
- Shakespeare's ruggedly engineered FRP poles are essential electric utility assets for today's modern, resilient grid.
- As part of Valmont Composite Structures, Shakespeare is a US-based industry leader with local expertise and global resources.
- For your next order, choose Shakespeare, the composite brand North American utilities have been relying on for decades.



Shakespeare

A valmont. BRAND

SHAKESPEARE TUFF-POLE™

PRODUCTS & ACCESSORIES

Shakespeare engineered composite Tuff-Pole structures are ideal for the modern-day, grid-reliability needs of electric utilities.

Resilient and durable, our transmission and distribution poles, crossarms, braces, pole-top extensions, and substation products are designed to withstand harsh environments for decades of service.

Installed in 1997, these Shakespeare composite poles are time-proven performers in rugged environments.



- **LIGHTWEIGHT DESIGN** – easy to transport to your installation site and individual composite poles may be lifted and carried by your crew into hard-to-reach locations.
- **EASE OF INSTALLATION** – composite poles can be directly buried into most any soil type, just as wood poles are.
- **LONG LASTING** – crafted to the core with embedded UV inhibitors, the pole is covered with a polyester veil which is coated with UV-protective finish.
- **LOW MAINTENANCE** – rust-proof and corrosion-resistant, pole maintenance costs are virtually eliminated; unlike wood, composites are impervious to insects, woodpeckers, and weather.
- **ENVIRONMENTALLY SOUND** – Unlike treated wood, Shakespeare composites need no harmful chemicals to protect from decay or insects. Also, easier to lift and install on ecologically sensitive land.
- **SAFE** – non-conductive composite construction is ideal for installation in highly populated areas such as neighborhoods, parking lots, and recreational facilities.
- **ATTRACTIVE** – strong visual appeal is provided with either our grey or dark-bronze standard colors. Custom color options may be available on large-quantity orders. Consult factory for details.

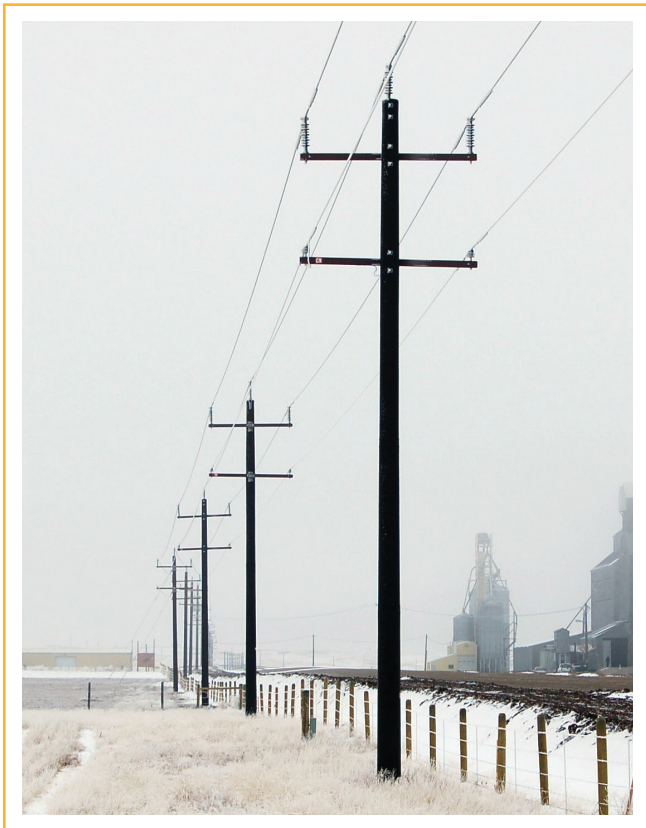
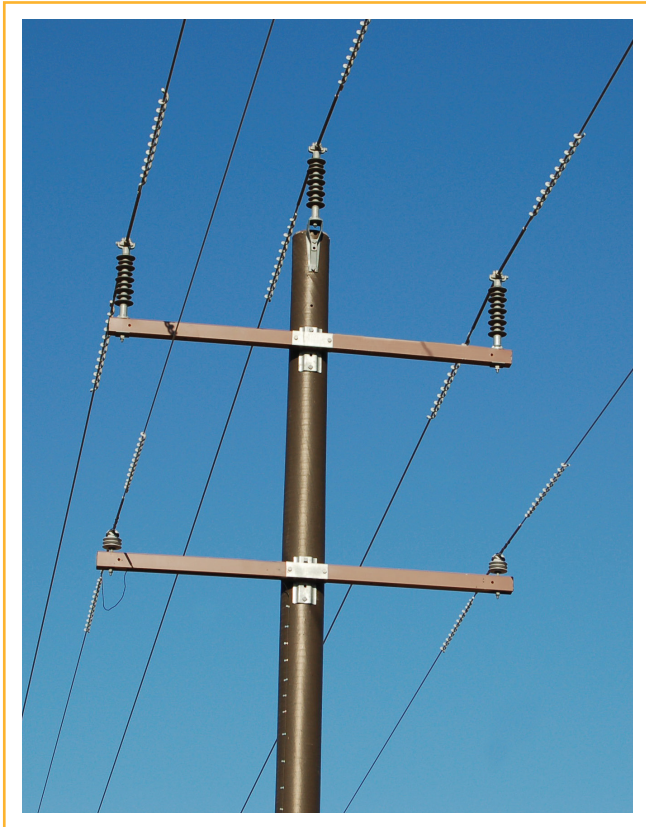

CONTENTS

- PAGE 4** Learn how Shakespeare Tuff-Pole™ composites compare to other materials
- PAGE 5** Durability demonstrated – Montana and California installations
- PAGE 6** The advantage of Shakespeare composites
- PAGE 7** Composite pole strength table and ordering template
- PAGE 8-11** Tuff-Pole product specification tables
- PAGE 12-13** Shakespeare composite crossarms
- PAGE 14-15** Composite braces (X-braces, Knee-braces, Vee-braces)
- PAGE 16-17** Pole top extensions
- PAGE 18-19** Substation products, including SafeFence™, buss supports, and switch supports
- PAGE 20** Generations of innovations – a history of firsts

©2017 Valmont Composite Structures. All rights reserved.

Valmont Composite Structures strives for continuous product improvement and development. As a result, certain changes in standard equipment, options, price, etc., may have occurred after the publication of this brochure. Some photographs and specifications may not be identical to current production. Valmont Composite Structures reserves the right to change product design and specifications at any time without incurring obligations.

ENGINEERED COMPOSITE STRUCTURES

PROVIDING UNMATCHED DURABILITY

If you were able to combine the advantages of steel, aluminum, PVC, plastic, and wood into a single structure, the resulting combination may very well be a Tuff-Pole™ composite product from Shakespeare. Strong yet lightweight, non-corrosive, dielectric, rust proof, and environmentally sound ... all these qualities are integrated into a single precision-engineered composite solution.



SMART ALTERNATIVE TO OTHER MATERIALS

Shakespeare Tuff-Pole structures feature a fiberglass reinforced plastic (FRP) composite construction that will often simply outlast wood and metal structures under the same climatic conditions. Further, compared to other materials, direct-embed composite poles are easy to install – potentially saving time, manpower, equipment, and money during installation. Unlike wood, our poles are completely free of knots, twists and imperfections that can accelerate wood-pole failure.

LONG-LIFE DURABILITY – Designed for use in all climate types and with remarkable performance longevity, Shakespeare products will not splinter and rot like wood, nor rust like metal. Unlike wood, composites are impervious to insects, woodpeckers, and weather. The specified strength factors remain intact over the product lifespan.

Shakespeare non-corroding composites will not deteriorate in extreme heat or cold, in salt-air climates, nor in desert installation. Regardless of humidity, they will not rust, ever, and they easily withstand harsh, natural, and industrial environments.

A TIME-PROVEN INNOVATION

DISPLAYING LONG LASTING PERFORMANCE

Shakespeare has been crafting composite products for utilities and municipalities for generations. Likewise, our valued customers count on Shakespeare year-after-year because our products are built to last for decades.

In Montana's Big Sky Country, near Glacier National Park, Shakespeare composite utility poles are subjected to some of the harshest natural conditions in the United States (see photos below, left and center). Sub-zero temperatures and blizzards are common in winter. In summer, blistering heat can permeate the wide-open spaces. For human safety and security, electric-power reliability is essential.

In a similar manner, the high-desert ecosystem adjacent to Sequoia National Park dishes out intense ambient conditions year-round (see photo below, right).

These photos display Shakespeare poles which have already been in service for more than 20 years. Uncommonly durable, Tuff-Pole engineered composites are designed to withstand harsh natural elements, enabling our utility customers to successfully serve those who reside in rugged, demanding environmental conditions.



SUPERB WEATHERING & UV PROTECTION – Shakespeare provides triple protection from ambient ultraviolet exposure. A proven process with more than 25 years of experience in the field.

1. During the production process, 100% of the glass-fiber strands and fiberglass-mat components are saturated with UV-inhibitor-laden resins.
2. Those materials are then covered with a tightly woven fiberglass veil that is saturated with a UV-inhibitor. This veil provides a resin-rich surface that controls blooming.
3. In post-production, the product receives an exterior coating of our high-performance, UV-protective urethane finish to help prevent color fading over time - for long-lasting good looks.

CHOOSE SHAKESPEARE FOR YOUR NEXT PROJECT

SERVING UTILITIES WITH EXCELLENCE, INTEGRITY

A pioneer in developing strong, durable composite products for the utility industry, Shakespeare's know-how and industry leadership are one of a kind.

Our team listens carefully to customer feedback and responds with products that meet or exceed utility specifications and expectations from across North America and beyond. Shakespeare's growing customer base appreciates the many advantages our transmission and distribution poles, crossarms, braces, pole tops, and substation composite products provide over other materials.

- **EASE OF INSTALLATION** – Up to one-third the weight of wood, Shakespeare composite structures can be carried at installation sites, saving utilities time and money. The sturdy, lightweight design is ideal for hard to reach areas, including homeowner's backyards, steep grades, and environmentally sensitive locations.
- **SAFE** – The high-strength to low-weight ratio of composites as compared to wood and metal may help alleviate possible injury to linemen, warehouse staff, and other utility personnel. Shakespeare poles are easier to transport, lift, and install than unwieldy wood or metal products. The composite material will not splinter like wood. Also, composite materials are non-conductive.
- **LOW MAINTENANCE** – Shakespeare's 100% maintenance-free construction saves time and money over the product lifetime. Our non-corroding composites will not deteriorate in salt-air climates, desert heat or acid rain. Regardless of humidity, they will not rust, ever, and they easily withstand harsh, industrial environments.
- **SUPERB CUSTOMER CARE** – Utility customers count on Shakespeare year-after-year because of the quality of our products and great care with which our agent network and factory respond to daily customer needs. Also, after significant storm events, when a rapid response is imperative, Shakespeare consistently meets the needs of utilities striving to restore power. For example, after a recent hurricane caused widespread power outages, Shakespeare produced and shipped more than 500 composite crossarms to 3 utility customers within 24 hours of the orders being received.
- **CONTACT SHAKESPEARE** – Since 2014, Shakespeare has been part of Valmont Composite Structures. A global leader in engineering and manufacturing structures for transmission and distribution applications, Valmont is a proven resource for utility customers across North America, Europe, Africa, Asia, India, and Australia.

ENGINEERED COMPOSITE TUFF-POLE™

COMPOSITE TUFF-POLE®

COMPOSITE POLES MAXIMUM STRENGTH AVAILABLE (CLASS EQUIVALENT)

| OVERALL POLE LENGTH | MAXIMUM ANSI TIP LOAD 2' FROM TOP | @STD BURIAL DEPTH (10% +2') | |
|---------------------------|---|---|---|
| | | MAXIMUM GROUNDLINE MOMENT (IN)KIPS | MAXIMUM GROUNDLINE MOMENT FT/LBS |
| 30' | >15,500# | >4,278 | >356,500 |
| 35' | >15,500# | >5,115 | >426,250 |
| 40' | >15,500# | >5,952 | >496,000 |
| 45' | >15,500# | >6,789 | >565,750 |
| 50' | 15,500# | 7,626 | 635,500 |
| 55' | 14,100# | 7,699 | 641,550 |
| 60' | 12,900# | 7,740 | 645,000 |
| 65' | 11,800# | 7,717 | 643,100 |
| 70' | 10,900# | 7,717 | 643,100 |
| 75' | 10,000# | 7,620 | 635,000 |
| 80' | 9,400# | 7,670 | 639,200 |
| 85' | 8,800# | 7,656 | 638,000 |
| 90' | 8,300# | 7,669 | 639,100 |
| 95' | 7,900# | 7,726 | 643,850 |
| 100' | 7,500# | 7,740 | 645,000 |
| 105' | 6,500# | 7,059 | 588,250 |
| 110' | 5,000# | 5,700 | 475,000 |
| 115' | 4,200# | 5,015 | 417,900 |
| 120' | 3,600# | 4,493 | 374,400 |
| 125' | 3,000# | 3,906 | 325,500 |

All poles over 50' are two-piece poles; poles over 90' are three-piece poles.



* WOOD POLE REFERENCE DATA

$$\text{Required Load Rating} = \frac{\text{Design Load X Overload Factor}}{\text{Strength Compensation Factor}}$$

Strength Compensation Factors:

Wood Poles: 0.65

Engineered Composites
(Fiber reinforced polymer structures): 1.0

* Ref: Tables 253-1 and 261-1A, NESC (2007 National Electric Safety Code)

Shakespeare's engineering composite Tuff-Poles do not require strength compensation. The strength you install does not change over time.

ORDERING TEMPLATE AND OPTIONS

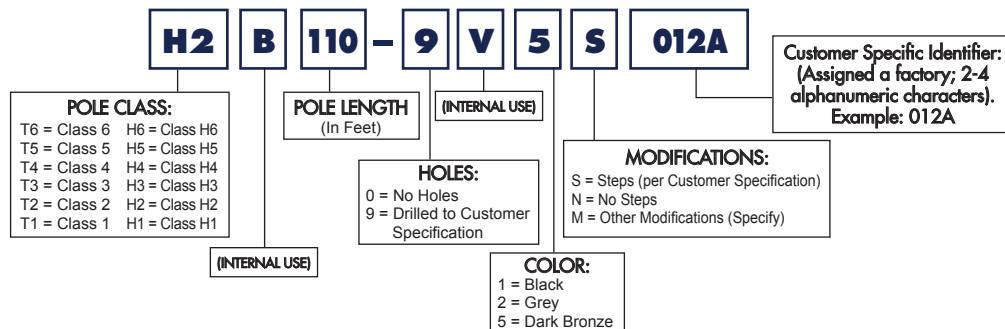

COMPOSITE TUFF-POLE®

| Length (Feet) | Class | ANSI Tip Load | Style# | Diameter (inches) | | | Weight (lbs.) | | | |
|------------------|-------|---------------------|--------|-------------------|------------|-------|-----------------|--------------|--------------|--------------|
| | | | | Butt | Groundline | Tip | Weight (sum) | Section 1 | Section 2 | Section 3 |
| 100 | H6 | 7410 | H6B100 | 22.49 | 20.81 | 9.9 | 4,622 | 2,587 | 1,802 | 233 |
| 95 | | | H6B95 | 22.38 | 20.77 | 10.27 | 4,175 | 2,402 | 1,663 | 110 |
| 90 | | | H6B90 | 22.26 | 20.72 | 10.95 | 3,823 | 2,217 | 1,525 | 81 |
| 85 | | | H6B85 | 22.14 | 20.67 | 12.09 | 3,366 | 2,033 | 1,333 | |
| 80 | | | H6B80 | 22.14 | 20.74 | 12.38 | 2,994 | 2,033 | 961 | |
| 75 | | | H6B75 | 22.03 | 20.7 | 12.86 | 2,597 | 1,848 | 749 | |
| 70 | | | H6B70 | 21.91 | 20.65 | 13.36 | 2,226 | 1,663 | 563 | |
| 65 | | | H6B65 | 21.91 | 20.72 | 13.88 | 2,066 | 1,663 | 403 | |
| 60 | | | H6B60 | 21.79 | 20.67 | 14.41 | 1,748 | 1,478 | 270 | |
| 55 | | | H6B55 | 21.67 | 20.62 | 14.95 | 1,457 | 1,294 | 163 | |
| 50 | | | H6B50 | 21.67 | 20.69 | 15.07 | 1,416 | 1,416 | | |
| 45 | | | H6B45 | 21.55 | 20.64 | 15.55 | 1,109 | 1,109 | | |
| 40 | | | H6B40 | 21.43 | 20.59 | 16.05 | 836 | 836 | | |
| 35 | | | H6B35 | 21.31 | 20.54 | 16.56 | 599 | 599 | | |
| 105 | H5 | 6500 | H5B105 | 22.38 | 20.63 | 9.42 | 4,543 | 2,402 | 1,802 | 339 |
| 100 | | | H5B100 | 22.26 | 20.58 | 9.9 | 4,113 | 2,217 | 1,663 | 233 |
| 95 | | | H5B95 | 22.14 | 20.53 | 10.27 | 3,667 | 2,033 | 1,524 | 110 |
| 90 | | | H5B90 | 22.14 | 20.6 | 10.95 | 3,500 | 2,033 | 1,386 | 81 |
| 85 | | | H5B85 | 22.03 | 20.56 | 11.93 | 3,048 | 1,848 | 1,200 | |
| 80 | | | H5B80 | 21.91 | 20.51 | 12.78 | 2,624 | 1,663 | 961 | |
| 75 | | | H5B75 | 21.91 | 20.58 | 12.71 | 2,305 | 1,663 | 642 | |
| 70 | | | H5B70 | 21.79 | 20.53 | 13.22 | 1,947 | 1,478 | 469 | |
| 65 | | | H5B65 | 21.79 | 20.6 | 13.74 | 1,801 | 1,478 | 323 | |
| 60 | | | H5B60 | 21.67 | 20.55 | 14.27 | 1,496 | 1,294 | 202 | |
| 55 | | | H5B55 | 21.55 | 20.5 | 14.95 | 1,272 | 1,109 | 163 | |
| 50 | | | H5B50 | 21.55 | 20.57 | 14.9 | 1,214 | 1,214 | | |
| 45 | | | H5B45 | 21.43 | 20.52 | 15.39 | 924 | 924 | | |
| 40 | | | H5B40 | 21.43 | 20.59 | 16.05 | 836 | 836 | | |
| 35 | | | H5B35 | 21.31 | 20.54 | 16.56 | 599 | 599 | | |
| 105 | H4 | 5655 | H4B105 | 22.1 | 20.35 | 9.42 | 3,827 | 1,963 | 1,525 | 339 |
| 100 | | | H4B100 | 22.03 | 20.35 | 9.76 | 3,421 | 1,848 | 1,386 | 187 |
| 95 | | | H4B95 | 21.98 | 20.37 | 10.41 | 3,161 | 1,767 | 1,247 | 147 |
| 90 | | | H4B90 | 21.91 | 20.37 | 11.08 | 2,880 | 1,663 | 1,109 | 108 |
| 85 | | | H4B85 | 21.85 | 20.38 | 11.69 | 2,582 | 1,571 | 1,011 | |
| 80 | | | H4B80 | 21.79 | 20.39 | 12.15 | 2,259 | 1,478 | 781 | |
| 75 | | | H4B75 | 21.72 | 20.39 | 12.62 | 1,954 | 1,374 | 580 | |
| 70 | | | H4B70 | 21.67 | 20.41 | 13.12 | 1,701 | 1,294 | 407 | |
| 65 | | | H4B65 | 21.6 | 20.41 | 13.74 | 1,501 | 1,178 | 323 | |
| 60 | | | H4B60 | 21.55 | 20.43 | 14.27 | 1,311 | 1,109 | 202 | |
| 55 | | | H4B55 | 21.47 | 20.42 | 14.95 | 1,145 | 982 | 163 | |
| 50 | | | H4B50 | 21.43 | 20.45 | 14.73 | 1,012 | 1,012 | | |
| 45 | | | H4B45 | 21.43 | 20.52 | 15.39 | 924 | 924 | | |
| 40 | | | H4B40 | 21.31 | 20.47 | 15.89 | 669 | 669 | | |
| 35 | | | H4B35 | 21.21 | 20.44 | 16.43 | 477 | 477 | | |
| 110 | H3 | 4875 | H3B110 | 22.03 | 20.21 | 8.96 | 3,699 | 1,848 | 1,386 | 465 |
| 105 | | | H3B105 | 21.98 | 20.23 | 9.26 | 3,401 | 1,767 | 1,351 | 283 |



COMPOSITE TUFF-POLE®



| Length (Feet) | Class | ANSI Tip Load | Style# | Diameter (inches) | | | Weight (lbs.) | | | |
|---------------|-------|---------------|---------------|-------------------|------------|-------|---------------|-----------|-----------|-----------|
| | | | | Butt | Groundline | Tip | Weight (sum) | Section 1 | Section 2 | Section 3 |
| 100 | | | H3B100 | 21.91 | 20.23 | 9.76 | 3,051 | 1,663 | 1,201 | 187 |
| 95 | | | H3B95 | 21.85 | 20.24 | 10.41 | 2,827 | 1,571 | 1,109 | 147 |
| 90 | | | H3B90 | 21.79 | 20.25 | 11.08 | 2,556 | 1,478 | 970 | 108 |
| 85 | | | H3B85 | 21.72 | 20.25 | 11.62 | 2,241 | 1,374 | 867 | |
| 80 | | | H3B80 | 21.67 | 20.27 | 12.08 | 1,945 | 1,294 | 651 | |
| 75 | | | H3B75 | 21.6 | 20.27 | 12.62 | 1,677 | 1,178 | 499 | |
| 70 | | | H3B70 | 21.55 | 20.29 | 13.18 | 1,484 | 1,109 | 375 | |
| 65 | | | H3B65 | 21.51 | 20.32 | 13.71 | 1,281 | 1,039 | 242 | |
| 60 | | | H3B60 | 21.43 | 20.31 | 14.39 | 1,126 | 924 | 202 | |
| 55 | | | H3B55 | 21.37 | 20.32 | 15.07 | 995 | 832 | 163 | |
| 50 | | | H3B50 | 21.34 | 20.36 | 14.59 | 860 | 860 | | |
| 45 | | | H3B45 | 21.31 | 20.4 | 15.22 | 739 | 739 | | |
| 40 | | | H3B40 | 21.21 | 20.37 | 15.75 | 533 | 533 | | |
| 35 | | | H3B35 | 21.19 | 20.42 | 16.4 | 449 | 449 | | |
| 115 | H2 | 4160 | H2B115 | 21.91 | 20.02 | 8.36 | 3,491 | 1,663 | 1,294 | 534 |
| 110 | | | H2B110 | 21.85 | 20.03 | 8.81 | 3,178 | 1,571 | 1,201 | 406 |
| 105 | | | H2B105 | 21.79 | 20.04 | 9.17 | 2,838 | 1,478 | 1,109 | 251 |
| 100 | | | H2B100 | 21.72 | 20.04 | 9.76 | 2,612 | 1,374 | 1,051 | 187 |
| 95 | | | H2B95 | 21.67 | 20.06 | 10.41 | 2,411 | 1,294 | 970 | 147 |
| 90 | | | H2B90 | 21.64 | 20.1 | 11.08 | 2,256 | 1,247 | 901 | 108 |
| 85 | | | H2B85 | 21.6 | 20.13 | 11.4 | 1,956 | 1,178 | 778 | |
| 80 | | | H2B80 | 21.55 | 20.15 | 11.9 | 1,710 | 1,109 | 601 | |
| 75 | | | H2B75 | 21.51 | 20.18 | 12.4 | 1,467 | 1,039 | 428 | |
| 70 | | | H2B70 | 21.47 | 20.21 | 12.96 | 1,287 | 982 | 305 | |
| 65 | | | H2B65 | 21.43 | 20.24 | 13.6 | 1,166 | 924 | 242 | |
| 60 | | | H2B60 | 21.34 | 20.22 | 14.27 | 987 | 785 | 202 | |
| 55 | | | H2B55 | 21.31 | 20.26 | 14.95 | 902 | 739 | 163 | |
| 50 | | | H2B50 | 21.31 | 20.33 | 14.55 | 809 | 809 | | |
| 45 | | | H2B45 | 17.01 | 16.1 | 11.07 | 751 | 751 | | |
| 40 | | | H2B40 | 16.92 | 16.08 | 11.59 | 585 | 585 | | |
| 35 | | | H2B35 | 15.29 | 14.52 | 10.63 | 486 | 486 | | |
| 30 | | | H2B30 | 15.25 | 14.55 | 11.24 | 372 | 372 | | |
| 120 | H1 | 3510 | H1B120 | 21.79 | 19.83 | 7.82 | 3,282 | 1,478 | 1,201 | 603 |
| 115 | | | H1B115 | 21.72 | 19.83 | 8.23 | 2,941 | 1,374 | 1,109 | 458 |
| 110 | | | H1B110 | 21.67 | 19.85 | 8.69 | 2,735 | 1,294 | 1,109 | 332 |
| 105 | | | H1B105 | 21.64 | 19.89 | 9.31 | 2,443 | 1,247 | 970 | 226 |
| 100 | | | H1B100 | 21.6 | 19.92 | 9.76 | 2,219 | 1,178 | 901 | 140 |
| 95 | | | H1B95 | 21.55 | 19.94 | 10.41 | 2,027 | 1,109 | 808 | 110 |
| 90 | | | H1B90 | 21.51 | 19.97 | 11.08 | 1,813 | 1,039 | 693 | 81 |
| 85 | | | H1B85 | 21.47 | 20 | 11.16 | 1,604 | 982 | 622 | |
| 80 | | | H1B80 | 21.43 | 20.03 | 11.7 | 1,405 | 924 | 481 | |
| 75 | | | H1B75 | 21.37 | 20.04 | 12.25 | 1,180 | 832 | 348 | |
| 70 | | | H1B70 | 21.34 | 20.08 | 12.88 | 1,066 | 785 | 281 | |
| 65 | | | H1B65 | 21.31 | 20.12 | 13.56 | 981 | 739 | 242 | |
| 60 | | | H1B60 | 21.31 | 20.19 | 14.23 | 941 | 739 | 202 | |
| 55 | | | H1B55 | 21.24 | 20.19 | 14.92 | 787 | 624 | 163 | |

COMPOSITE TUFF-POLE®

| Length (Feet) | Class | ANSI Tip Load | Style# | Diameter (inches) | | | Weight (lbs.) | | | |
|---------------|-------|---------------|---------------|-------------------|------------|-------|---------------|-----------|-----------|-----------|
| | | | | Butt | Groundline | Tip | Weight (sum) | Section 1 | Section 2 | Section 3 |
| 50 | | | H1B50 | 21.19 | 20.21 | 14.37 | 607 | 607 | | |
| 45 | | | H1B45 | 16.92 | 16.01 | 10.94 | 647 | 647 | | |
| 40 | | | H1B40 | 16.85 | 16.01 | 11.48 | 502 | 502 | | |
| 35 | | | H1B35 | 15.29 | 14.52 | 10.63 | 449 | 449 | | |
| 30 | | | H1B30 | 15.19 | 14.49 | 11.15 | 322 | 322 | | |
| 25 | | | H1B25 | 15.16 | 14.53 | 11.78 | 258 | 258 | | |
| 125 | 1 | 2925 | T1B125 | 21.64 | 19.61 | 11.47 | 2,970 | 1,247 | 1,051 | 672 |
| 120 | | | T1B120 | 21.64 | 19.68 | 11.99 | 2,734 | 1,247 | 970 | 517 |
| 115 | | | T1B115 | 21.6 | 19.71 | 12.53 | 2,460 | 1,178 | 901 | 381 |
| 110 | | | T1B110 | 21.55 | 19.73 | 13.09 | 2,276 | 1,109 | 901 | 266 |
| 105 | | | T1B105 | 21.51 | 19.76 | 13.77 | 2,097 | 1,039 | 832 | 226 |
| 100 | | | T1B100 | 21.47 | 19.79 | 14.45 | 1,920 | 982 | 751 | 187 |
| 95 | | | T1B95 | 21.43 | 19.82 | 15.13 | 1,764 | 924 | 693 | 147 |
| 90 | | | T1B90 | 21.43 | 19.89 | 15.81 | 1,633 | 924 | 601 | 108 |
| 85 | | | T1B85 | 21.37 | 19.9 | 11.2 | 1,365 | 832 | 533 | |
| 80 | | | T1B80 | 21.34 | 19.94 | 11.73 | 1,176 | 785 | 391 | |
| 75 | | | T1B75 | 17.15 | 15.82 | 7.95 | 1,451 | 970 | 481 | |
| 70 | | | T1B70 | 17.09 | 15.83 | 8.28 | 1,214 | 901 | 313 | |
| 65 | | | T1B65 | 17.02 | 15.83 | 8.73 | 1,050 | 808 | 242 | |
| 60 | | | T1B60 | 16.97 | 15.85 | 9.34 | 903 | 751 | 152 | |
| 55 | | | T1B55 | 16.89 | 15.84 | 10.01 | 769 | 647 | 122 | |
| 50 | | | T1B50 | 16.81 | 15.83 | 10.14 | 607 | 607 | | |
| 45 | | | T1B45 | 16.85 | 15.94 | 10.82 | 554 | 554 | | |
| 40 | | | T1B40 | 15.96 | 15.12 | 10.63 | 502 | 502 | | |
| 35 | | | T1B35 | 15.19 | 14.42 | 10.49 | 365 | 365 | | |
| 30 | | | T1B30 | 14.47 | 13.77 | 10.43 | 297 | 297 | | |
| 25 | | | T1B25 | 11.88 | 11.25 | 8.59 | 258 | 258 | | |
| 125 | 2 | 2405 | T2B125 | 21.51 | 19.48 | 6.93 | 0 | | | |
| 120 | | | T2B120 | 21.47 | 19.51 | 7.4 | 0 | | | |
| 115 | | | T2B115 | 21.43 | 19.54 | 7.91 | 0 | | | |
| 110 | | | T2B110 | 21.43 | 19.61 | 8.46 | 1,883 | 924 | 693 | 266 |
| 105 | | | T2B105 | 21.37 | 19.62 | 9.1 | 1,751 | 832 | 693 | 226 |
| 100 | | | T2B100 | 21.37 | 19.69 | 9.76 | 1,712 | 832 | 693 | 187 |
| 95 | | | T2B95 | 21.34 | 19.73 | 10.41 | 1,486 | 785 | 554 | 147 |
| 90 | | | T2B90 | 21.31 | 19.77 | 11.08 | 1,401 | 739 | 554 | 108 |
| 85 | | | T2B85 | 21.31 | 19.84 | 10.87 | 1,139 | 739 | 400 | |
| 80 | | | T2B80 | 17.04 | 15.64 | 7.36 | 1,373 | 832 | 541 | |
| 75 | | | T2B75 | 17.15 | 15.82 | 7.76 | 1,233 | 832 | 401 | |
| 70 | | | T2B70 | 17.04 | 15.78 | 8.2 | 1,113 | 832 | 281 | |
| 65 | | | T2B65 | 17.04 | 15.85 | 8.84 | 935 | 693 | 242 | |
| 60 | | | T2B60 | 17.04 | 15.92 | 9.49 | 895 | 693 | 202 | |
| 55 | | | T2B55 | 16.92 | 15.87 | 10.15 | 856 | 693 | 163 | |
| 50 | | | T2B50 | 16.81 | 15.83 | 10.14 | 607 | 607 | | |
| 45 | | | T2B45 | 16.73 | 15.82 | 10.64 | 416 | 416 | | |
| 40 | | | T2B40 | 15.82 | 14.98 | 10.42 | 376 | 376 | | |
| 35 | | | T2B35 | 15.16 | 14.39 | 10.44 | 337 | 337 | | |

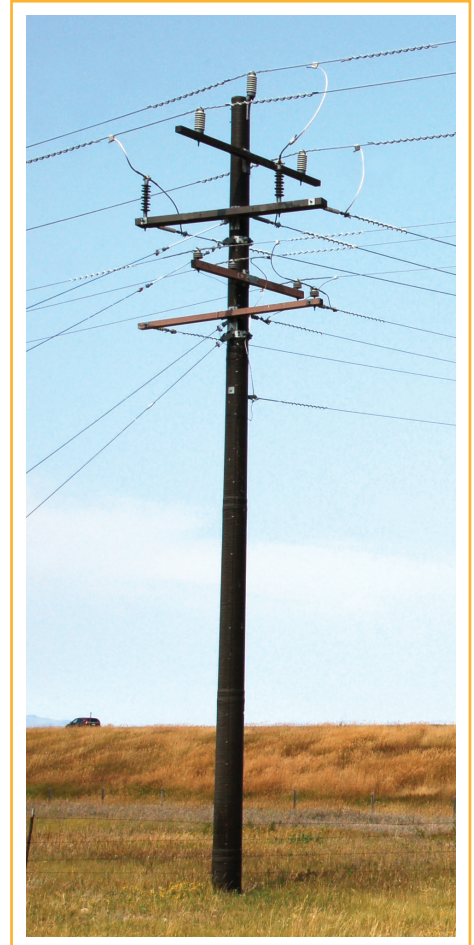

COMPOSITE TUFF-POLE®

| Length (Feet) | Class | ANSI Tip Load | Style# | Diameter (inches) | | | Weight (lbs.) | | | |
|---------------|-------|---------------|--------------|-------------------|------------|-------|---------------|-----------|-----------|-----------|
| | | | | Butt | Groundline | Tip | Weight (sum) | Section 1 | Section 2 | Section 3 |
| 30 | | | T2B30 | 14.47 | 13.77 | 10.43 | 297 | 297 | | |
| 25 | | | T2B25 | 11.88 | 11.25 | 8.59 | 258 | 258 | | |
| 90 | 3 | 1950 | T3B90 | 21.21 | 19.67 | 11.08 | 1,078 | 554 | 416 | 108 |
| 85 | | | T3B85 | 21.19 | 19.72 | 10.91 | 1,001 | 601 | 400 | |
| 80 | | | T3B80 | 21.19 | 19.79 | 11.57 | 914 | 554 | 360 | |
| 75 | | | T3B75 | 21.19 | 19.86 | 12.25 | 806 | 485 | 321 | |
| 70 | | | T3B70 | 21.19 | 19.93 | 12.92 | 731 | 450 | 281 | |
| 65 | | | T3B65 | 16.85 | 15.66 | 8.84 | 658 | 416 | 242 | |
| 60 | | | T3B60 | 16.79 | 15.67 | 9.49 | 618 | 416 | 202 | |
| 55 | | | T3B55 | 16.76 | 15.71 | 10.15 | 579 | 416 | 163 | |
| 50 | | | T3B50 | 16.73 | 15.75 | 9.98 | 455 | 455 | | |
| 45 | | | T3B45 | 16.73 | 15.82 | 10.64 | 416 | 416 | | |
| 40 | | | T3B40 | 15.82 | 14.98 | 10.42 | 376 | 376 | | |
| 35 | | | T3B35 | 15.16 | 14.39 | 10.44 | 337 | 337 | | |
| 30 | | | T3B30 | 11.88 | 11.18 | 7.95 | 297 | 297 | | |
| 25 | | | T3B25 | 11.88 | 11.25 | 8.59 | 258 | 258 | | |
| 70 | 4 | 1560 | T4B70 | 16.76 | 15.5 | 8.2 | 731 | 450 | 281 | |
| 65 | | | T4B65 | 16.73 | 15.54 | 8.84 | 658 | 416 | 242 | |
| 60 | | | T4B60 | 16.73 | 15.61 | 9.49 | 618 | 416 | 202 | |
| 55 | | | T4B55 | 16.73 | 15.68 | 10.15 | 579 | 416 | 163 | |
| 50 | | | T4B50 | 16.73 | 15.75 | 9.98 | 455 | 455 | | |
| 45 | | | T4B45 | 16.73 | 15.82 | 10.64 | 416 | 416 | | |
| 40 | | | T4B40 | 15.82 | 14.98 | 10.42 | 376 | 376 | | |
| 35 | | | T4B35 | 15.16 | 14.39 | 10.44 | 337 | 337 | | |
| 30 | | | T4B30 | 11.88 | 11.18 | 7.95 | 297 | 297 | | |
| 25 | | | T4B25 | 11.88 | 11.25 | 8.59 | 258 | 258 | | |
| 35 | 5 | 1235 | T5B35 | 11.76 | 10.99 | 7.12 | 250 | 250 | | |
| 30 | | | T5B30 | 11.76 | 11.06 | 7.76 | 223 | 223 | | |
| 25 | | | T5B25 | 11.76 | 11.2 | 8.42 | 148 | 223 | | |
| 35 | 6 | 975 | T6B35 | 11.76 | 10.99 | 7.12 | 207 | 207 | | |
| 30 | | | T6B30 | 11.76 | 11.06 | 7.76 | 178 | 178 | | |
| 25 | | | T6B25 | 11.76 | 11.2 | 8.42 | 148 | 148 | | |



ENGINEERED EXCELLENCE SUPPORTS CUSTOMER NEEDS

SPECIFY SHAKESPEARE CROSSARMS FOR YOUR NEXT PROJECT

Shakespeare composite structures are an ideal choice for power-distribution and power-transmission tangent crossarms. Our composite crossarms can be installed with ease, on any utility pole, whether the pole is a wood, steel, concrete, aluminum, or composite material.

With more than a million crossarms installed over the past 25 years, Shakespeare composite structures provide an exceptional return on investment.

When compared with conventional crossarms, these FRP beams will not rot or splinter like wood and provide a far superior strength-to-weight ratio. The engineered designs are free from knots and imperfections that can cause failure over time. As such, Shakespeare composites are increasingly the preferred choice on new installations and for the replacement of aging infrastructure on power transmission and distribution infrastructure.

Shakespeare offers the widest selection of composite crossarms in the industry with lengths up to 40' in six different profiles from 3.5" x 4.5" to 4" x 7.5".

- **S-SERIES:** 3.5" x 4.5" x .18"
- **M-SERIES:** 3.5" x 4.5" x .25"-.30"
- **H-SERIES:** 3.5" x 4.5" x .38"
- **T-SERIES:** 3.5" x 4.5" x .38"
- **I-SERIES:** 4" x 6"
- **X-SERIES:** 4" x 7.5"
- **4"X4" AND 5"X5" CROSSARMS** are also available for special applications.

Shakespeare takes a systematic approach to UV protection, and formulates UV inhibitors into the liquid resin mixture from the beginning of the production process. Our crossarm outer shell then is covered with a tightly woven fiberglass veil that is saturated with a UV-inhibitor. This veil provides a resin-rich surface that controls blooming. In post-production, the finished product receives an exterior coating of our high-performance, UV-protective urethane finish.

Product performance is proven by 25 years of in-field installations. Further, extensive accelerated testing is performed at the factory to verify current-product longevity.

To prevent the risk of internal moisture contamination, inside every Shakespeare tangent crossarm we inject closed-cell polyurethane foam that seals the beam. This allows for easy field drilling along the entire length of the arm during installation, with no special tools required. Also, Shakespeare can pre-drill the arms prior to shipment, as per specified requirements. Download the *Shakespeare Crossarm Products* brochure from www.skp-cs.com to learn more.

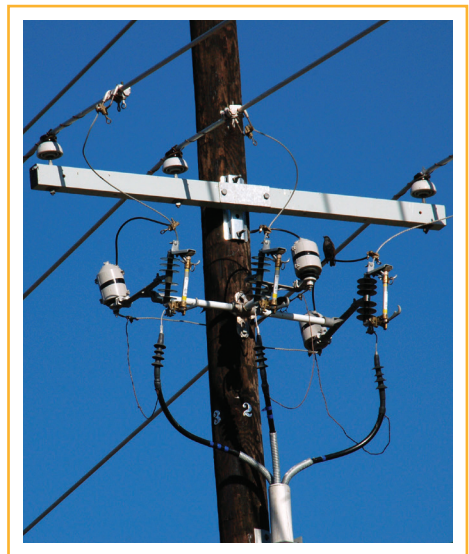
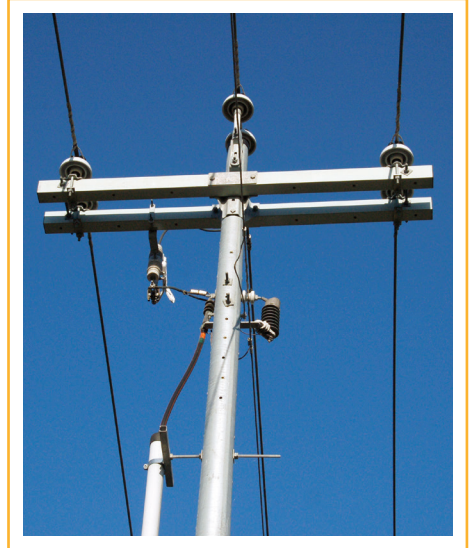

RUGGED END CAPS PROVIDE CROSSARM PROTECTION

Shakespeare pioneered the use of highly durable, impact-resistant end caps on composite crossarms. Our crossarm end caps are produced by an injection molding process. During production, these are inserted into the crossarm and foamed into place. Our process ensures end caps will remain securely in place and not come off of the arm.

Shakespeare crossarm and deadend assembly end caps are made of a thermoplastic that exhibits optimal flexibility during temperature extremes. The flexibility is also important because it helps protect the end of the crossarm during the shipping, storing and handling of the product.

SEE THE SHAKESPEARE DIFFERENCE

LAYERS OF INNOVATION AND TRIPLE UV CROSSARM PROTECTION FOR LONG LASTING DURABILITY

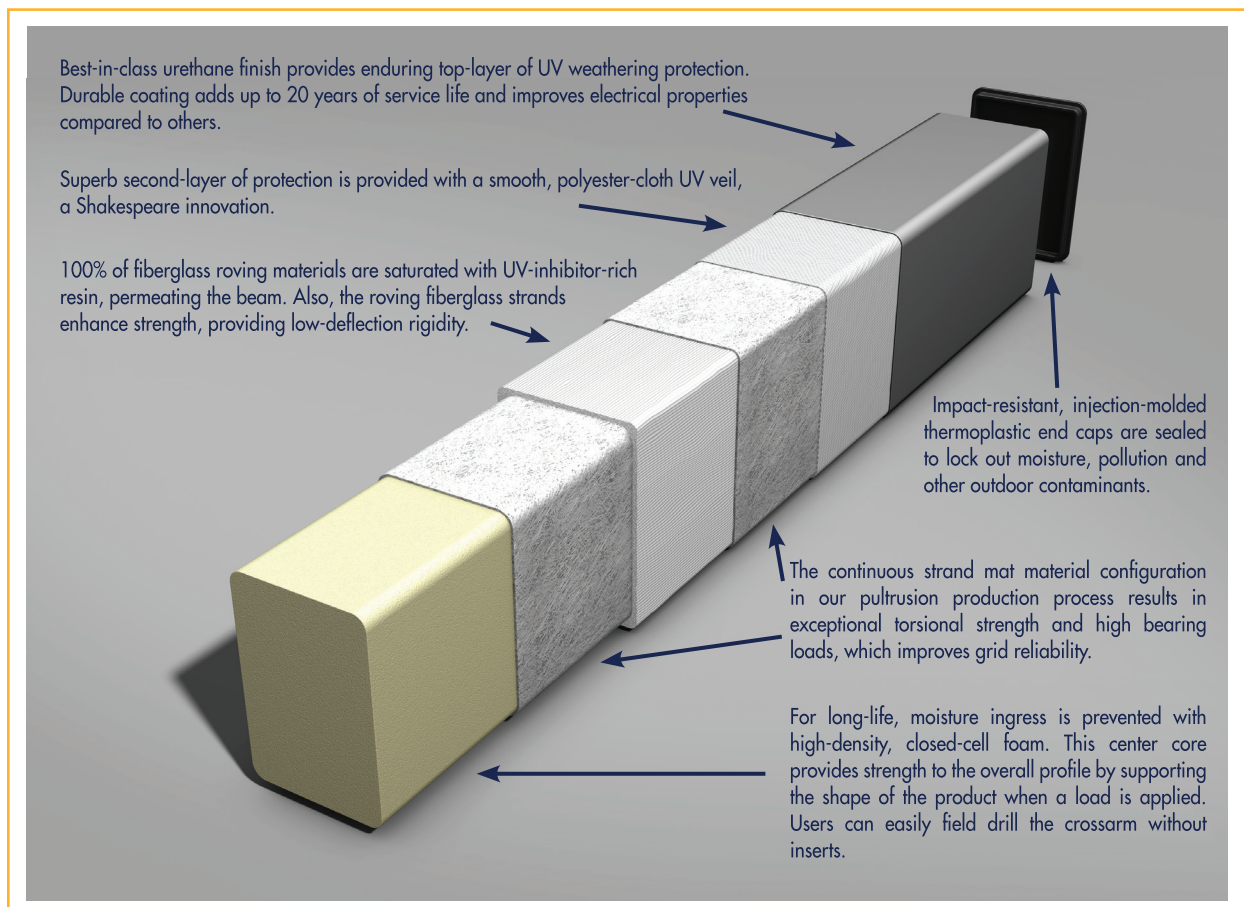

COMPOSITE BRACES ADD SUPPORT AND DURABILITY

COMPOSITE X-BRACES

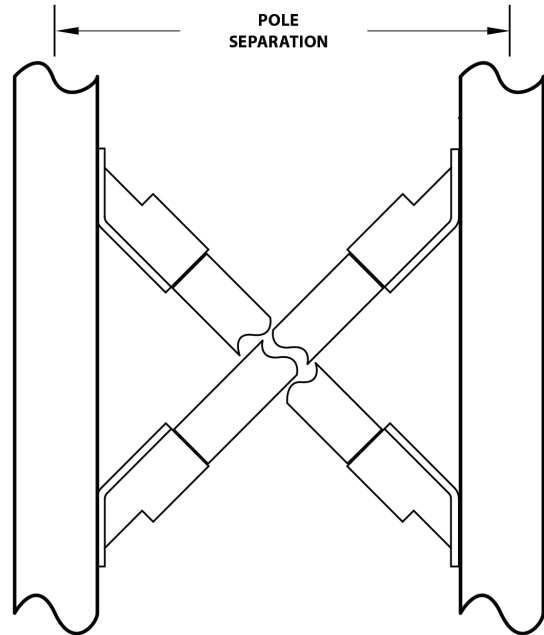

X-BRACES

| CATALOG NUMBER | POLE SPACING (in.) | PROFILE DIMENSIONS |
|----------------|--------------------|--------------------|
| BSX15-000144-5 | 144 | 3½" x 4½" |
| BHX15-000144-5 | 144 | 3½" x 4½" |
| BIX15-000144-5 | 144 | 4" x 6" |
| BXX15-000144-5 | 144 | 4" x 7½" |

ORDERING COMPOSITE X-BRACES

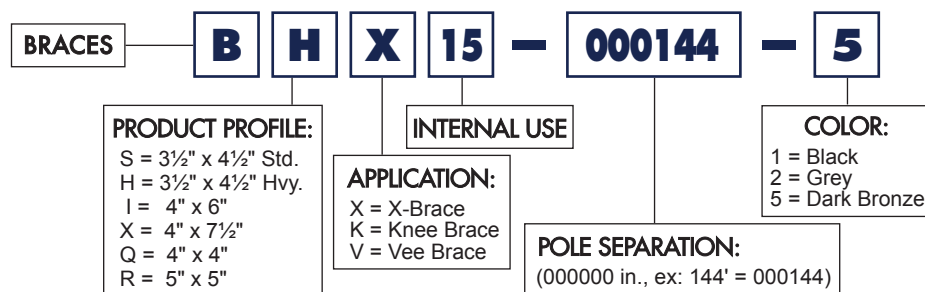

COMPOSITE KNEE AND VEE BRACES

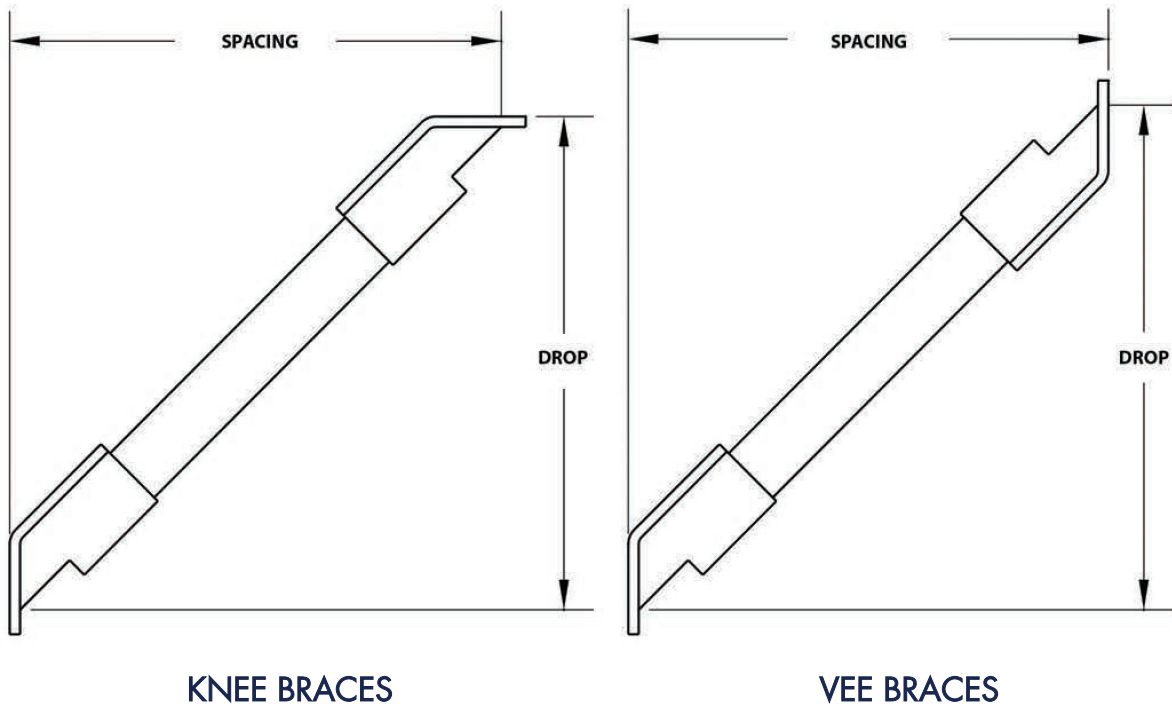

KNEE BRACES

VEE BRACES

ORDERING COMPOSITE KNEE AND VEE BRACES

BRACES — **B H K 10** — **C C 1018** — **2**

PRODUCT PROFILE:
 S = 3½" x 4½" Std.
 H = 3½" x 4½" Hvy.
 I = 4" x 6"
 X = 4" x 7½"
 Q = 4" x 4"
 R = 5" x 5"

INTERNAL USE

APPLICATION:
 K = Knee Brace
 V = Vee Brace

COLOR:
 1 = Black
 2 = Grey
 5 = Dark Bronze

LENGTH HOLE CENTER TO HOLE CENTER:
 (000.0 in., ex: 101.8" = 1018)

1ST END FITTING:
 (From Series Chart)

2ND END FITTING:
 (From Series Chart)

| END FITTING SERIES CHART | | |
|--------------------------|---------------|---------------|
| SIZE | FITTING ANGLE | MOUNTING HOLE |
| A | 30° | 13/16" |
| B | 37° | 13/16" |
| C | 45° | 13/16" |
| D | 52° | 13/16" |
| E | 60° | 13/16" |

THERE IS ALWAYS ROOM AT THE TOP

SHAKESPEARE TUFF-TOP POLE EXTENSIONS

- Filled with structural foam, a Shakespeare exclusive.
- Available in a range of strength ratings
- Light weight, easily installed
- Unexcelled strength, high load capacities
- Adjustable 6" to 10" for pole diameter (19" to 31" circumference)
- Aesthetically pleasing for any composite, wood, steel, or concrete pole.

Shakespeare Tuff-Top Pole Extensions provide a convenient, inexpensive, and durable way to add conductors or increase clearance on an existing pole installation, whether composite or other type of pole. These strong, attractive extensions are factory assembled from a length of fiberglass reinforced composite pole, plus a versatile attachment bracket. The pole sections are **filled with a durable, permanent, structural foam** that excludes insects and water and discourages flexing. The versatile attachment brackets either bolt through the pole or, for strongest applications, clamp on. Either way, you can add one or more crossarms, as well as a ridge pin and other attachments. The pole sections come in three standard colors, or you can specify.

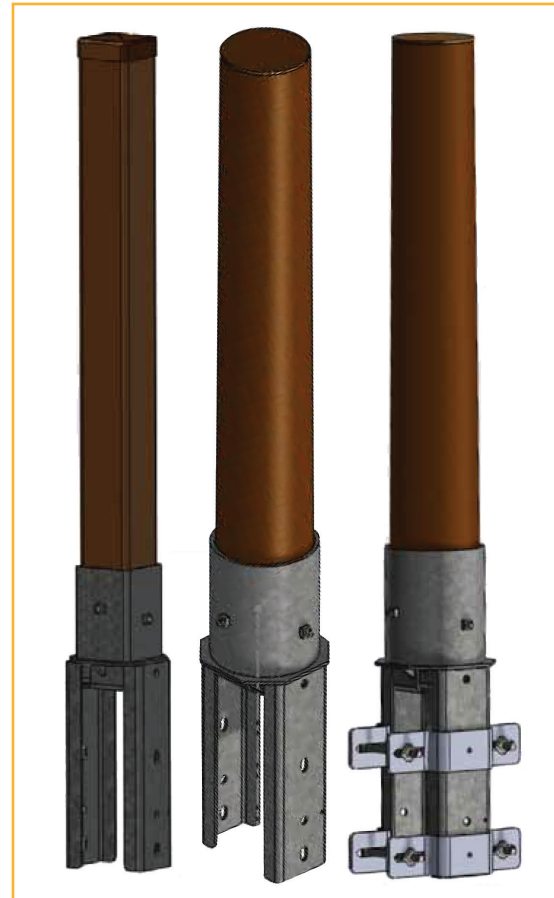

PTS Series (left); PTR (center); PTR with clamp style attachment (right)

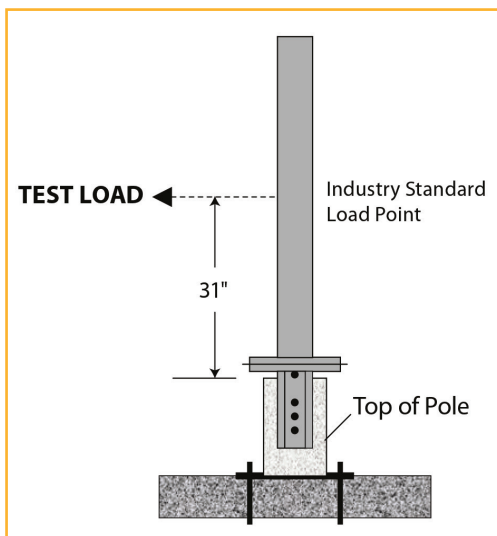

TUFF-TOP TEST DATA

| SERIES | ULTIMATE LOAD | |
|--------|---------------|----------------|
| | (lbs @ 31") | (ft/lbs @ 31") |
| PTS | 5,500 | 14,208 |
| PTH | 6,500 | 16,790 |
| PTX | 8,500 | 21,958 |
| PTR | 8,500 | 21,958 |



TUFF-TOP POLE EXTENSIONS

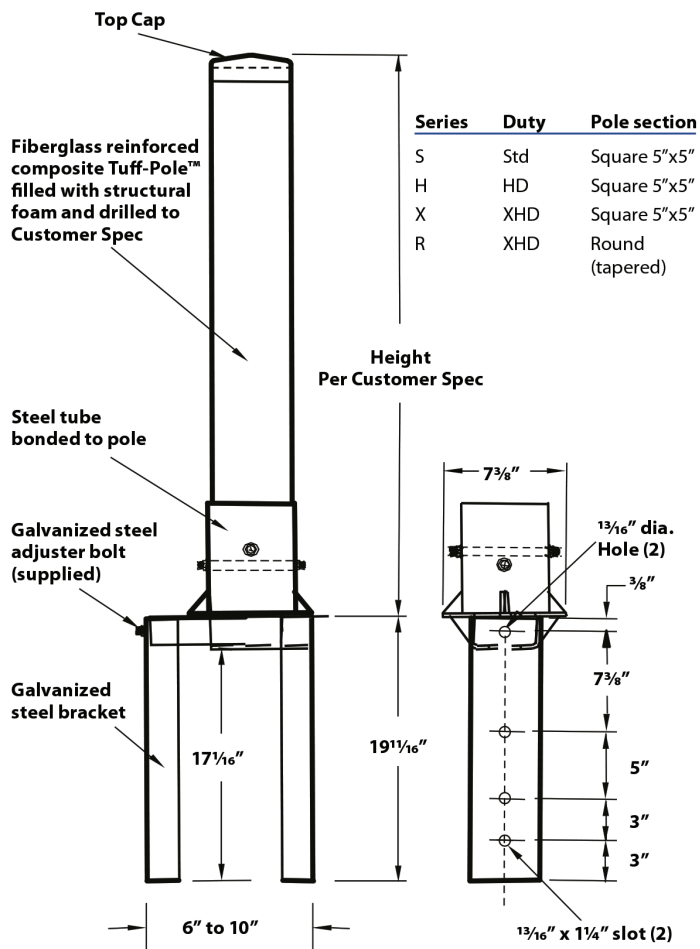
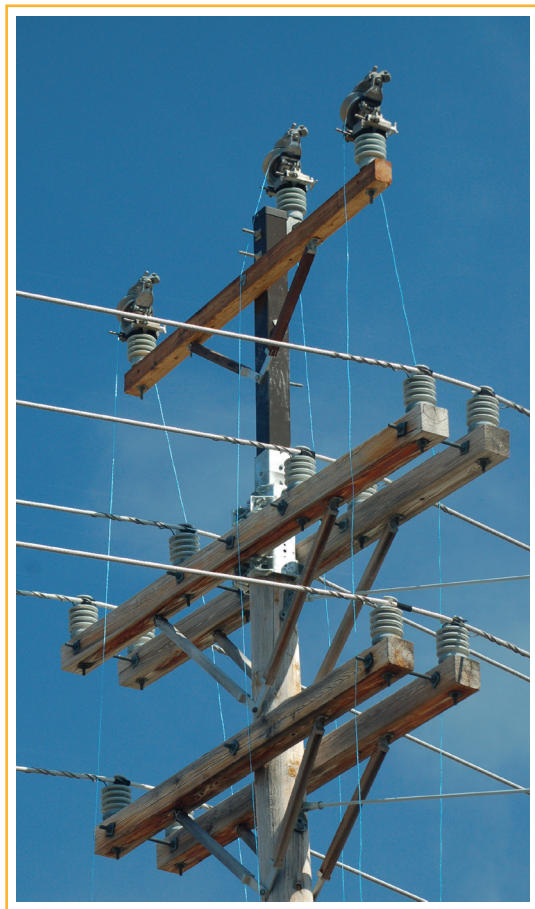

ORDERING TUFF-TOP POLE EXTENSIONS

HOW TO ORDER

The Shakespeare Tuff-Top Pole Extensions ordering logic is shown at the right. Use this checklist and the diagram above to specify the product you need. If you need assistance, just call.

| | STANDARD | SPECIFY |
|------------------------|------------------|---------|
| Series | S (Std) | |
| Attachment Type | B (Bolt Through) | |
| Length | 54" | |
| Color | Dark Bronze (5) | |
| Cap Type | C (Cap Only) | |
| Drilling Pattern | UD (Undrilled) | |
| Dia. of Drilling Holes | 1 1/16" | |
| Other | | |

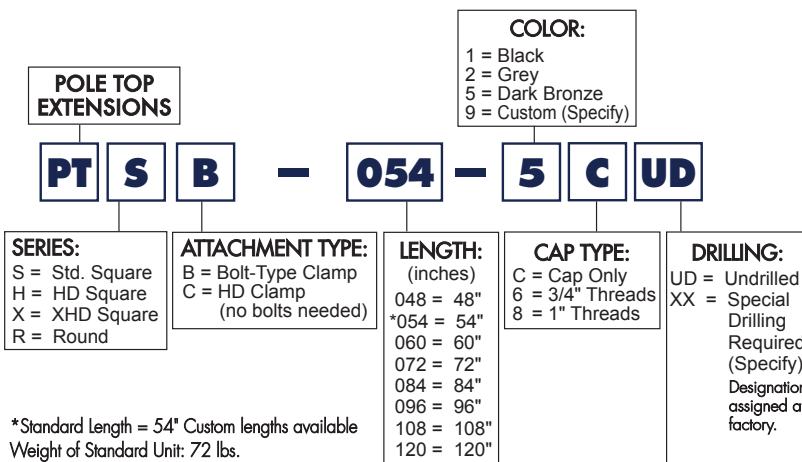

COMPOSITE BUSS AND SWITCH SUPPORTS

- Greatly reduce outages caused by wildlife intrusion or contact.
- Light weight, high load capacities
- Easily installed using standard construction practice
- Custom fabricated to your specification
- Predrilled to your specifications, or drill on site
- Custom fabricated attachment brackets



STOP THE SWITCHING STATION BARBECUE, AND MAKE YOUR CUSTOMERS HAPPY!



Here come the squirrels! A single squirrel can interrupt thousands of people's dinner, just because the squirrel can't read "High Voltage" on the fence around your switching station. Our strong, attractive fiberglass reinforced composite switch supports are a squirrel's best friend. And yours, too. Those pesky squirrels and other wildlife can poke their noses where they don't belong and not have to notify their next of kin. They can hop onto our fiberglass composite buss and switch supports with a much lower possibility of shorting to ground, causing an outage for your customers.

Shakespeare Composite Structures switch supports are built to your specifications using strong, field-tested fiberglass reinforced composite beams, plus custom fabricated brackets and hardware. The supports can be predrilled for fast assembly on site, or you can field drill them as necessary.

For more information, just call.



- **Non-Conductive** fiberglass supports and panels
- Simple, fast, inexpensive installation
- Can be modified and cut in the field
- Low maintenance over life of product
- Wide variety of RAL colors available
- Spans up to 18 feet
- Will not rust, rot, or corrode
- Lightweight, can be installed with minimal equipment

Download the Safe Fence Substation Perimeter Barrier product brochure from www.skp-cs.com to learn more.





GENERATIONS OF INNOVATIONS

**SUPERB QUALITY AND PERFORMANCE
SHAPES THE SHAKESPEARE STORY**

Shakespeare's composite product origins date back 65 years. For the utility market, Shakespeare's first innovation was to design and produce the first commercially successful composite light pole in 1967. Building logically on the fiberglass reinforced composite technologies developed for this and other demanding applications, the company's engineers scaled the manufacturing processes up to create a range of strong, durable composite structures, including utility transmission and distribution poles and of course, crossarms.

Over the years, our continued innovation has developed proprietary and custom formulated resins, coatings, and assembly techniques to achieve unmatched quality and durability.

Today, millions of our composite products are performing in every conceivable application, weathering every storm, every season. Impervious to the elements, our fiberglass retains its lustrous beauty for generations, and its strength never wears out or tires. Our composite structures are built to sustain heavy loads and look great doing it.

SHAKESPEARE COMPOSITE PRODUCTS A HISTORY OF FIRSTS

- 1967 First composite light pole installation
- 1974 First composite light pole filament winding machine - direct burial
- 1978 First full surface filament winding machine
- 1979 First anchor base fiberglass composite poles
- 1980 First smooth surface fiberglass poles
- 1986 First light pole arms
- 1987 First full surface filament winding machine for poles up to 47 feet
- 1989 First breakaway composite light poles
- 1991 First CAD/CAM computer controlled filament winding machine
- 1992 First Lewtex® composite crossarm shipped, company later acquired by Shakespeare
- 1992 First historical reproduction composite light poles
- 1992 First pultrusion of 5" x 5" straight square composite light poles
- 1993 First composite distribution poles
- 1995 First composite transmission poles up to 70 feet
- 1996 First installation of transmission poles
- 1997 First Tuff-Pole® programmed process
- 2000 First composite burial foot
- 2003 First affordable TL-2 full-scale tested Energy Absorbing Pole
- 2007 First fiberglass composite poles to 125 feet
- 2009 First fiberglass composite poles to 130 feet
- 2009 First non-conductive composite safety fencing system for utility substations
- 2010 First sound-absorptive, non-conductive composite safety fence to protect people and utility assets
- 2014 Acquired by Valmont Industries, Inc. (NYSE: VMI) – a global leader in engineered utility structures
- 2014 Shakespeare is a part of Valmont Composite Structures – a composite innovations leader
- 2016 Launch T-Series, M-Series composite crossarms
- 2017 First Matrix™ crossarm insert

19845 US Highway 76 • Newberry, SC 29108 USA
Phone: 803.276.5504 • 800.800.9008 • Fax: 803.276.8940
skp-cs.com